



AT 22
22 Tonne Lifting Capacity
Pick & Carry Crane
Datasheet
Metric

AT 22



Features: AT 22

- ▶ 22 tonne at 1.4 m radius
- ▶ 1.7 tonne at 15.8 m radius
- ▶ 17 m maximum hook height
- ▶ Hook block (4 parts) capacity 16.8 tonne
- ▶ Single line 4.2 tonne

WORKS FOR YOU.™

Key

.....	3
-------	---

Dimensions

Crane dimensions	4, 5
Range diagram	6
Area of operation	7

Load charts

Fallblock	8
Fallblock, manual	9

Technical description

Boom and Jib	10
Winch	10
Engine and transmission	10
Hydraulic system	11
Chassis	11
Tyres	11
Vehicle performance	12
Cab, controls, and operator aids	12

	Boom length		Speed
	Hook height		Slewing / Allowable slewing range
	Boom with jib		Crane / Crane in standard configuration
	Telescoping mode		Gradeability
	Boom elevation angle		Gross vehicle weight
	Working radius		Weight on front axle
	Hook and block		Weight on rear axle
	On rubber		Controls
	Main winch		Cab
	Winch speed		Air conditioning / Cab heating
	Engine		Operator aids / Load limiter / Load indicator
	Transmission		Rope – Standard / Optional
	Hydraulics		Rope diameter
	Steering		Rope length
	Tyres		Maximum line pull

DIMENSIONS

AT 22

Crane Dimensions

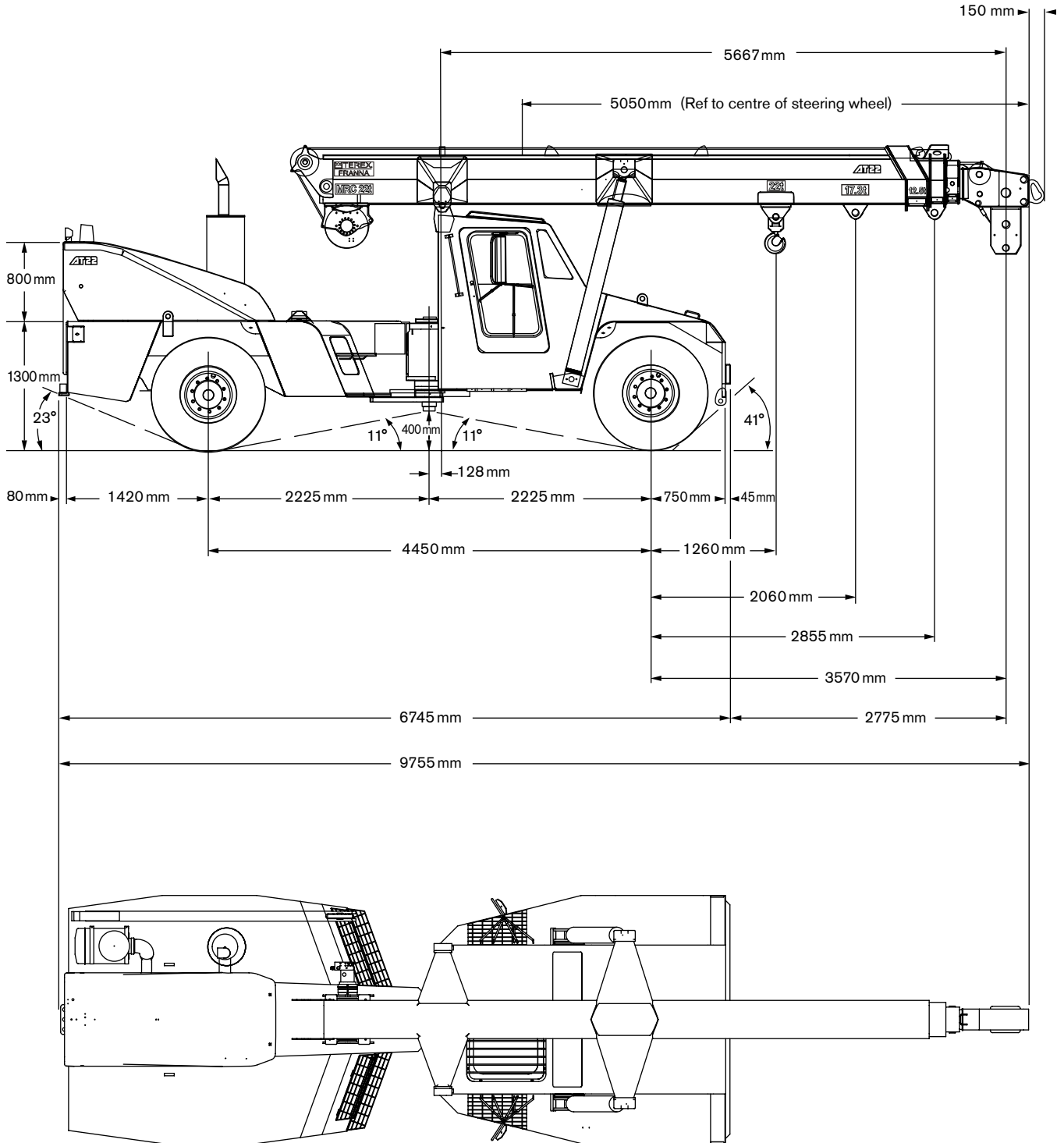

DIMENSIONS

AT 22

Crane Dimensions

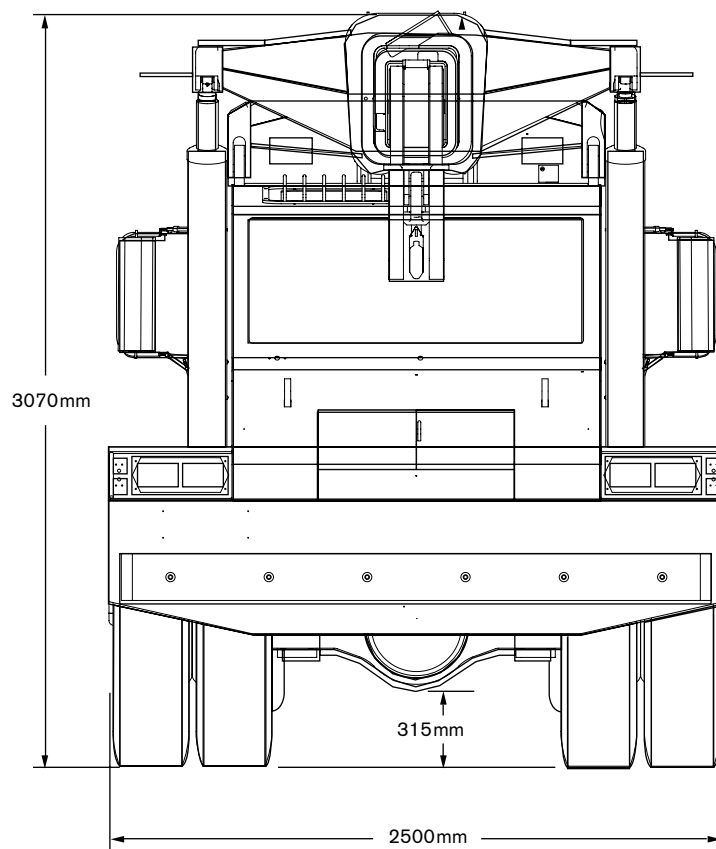

RADIUS LOAD CHART

AT22

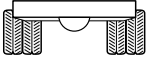

Pick & Carry 0.4 m/s (1.44 km/h); On rubber 66.6%

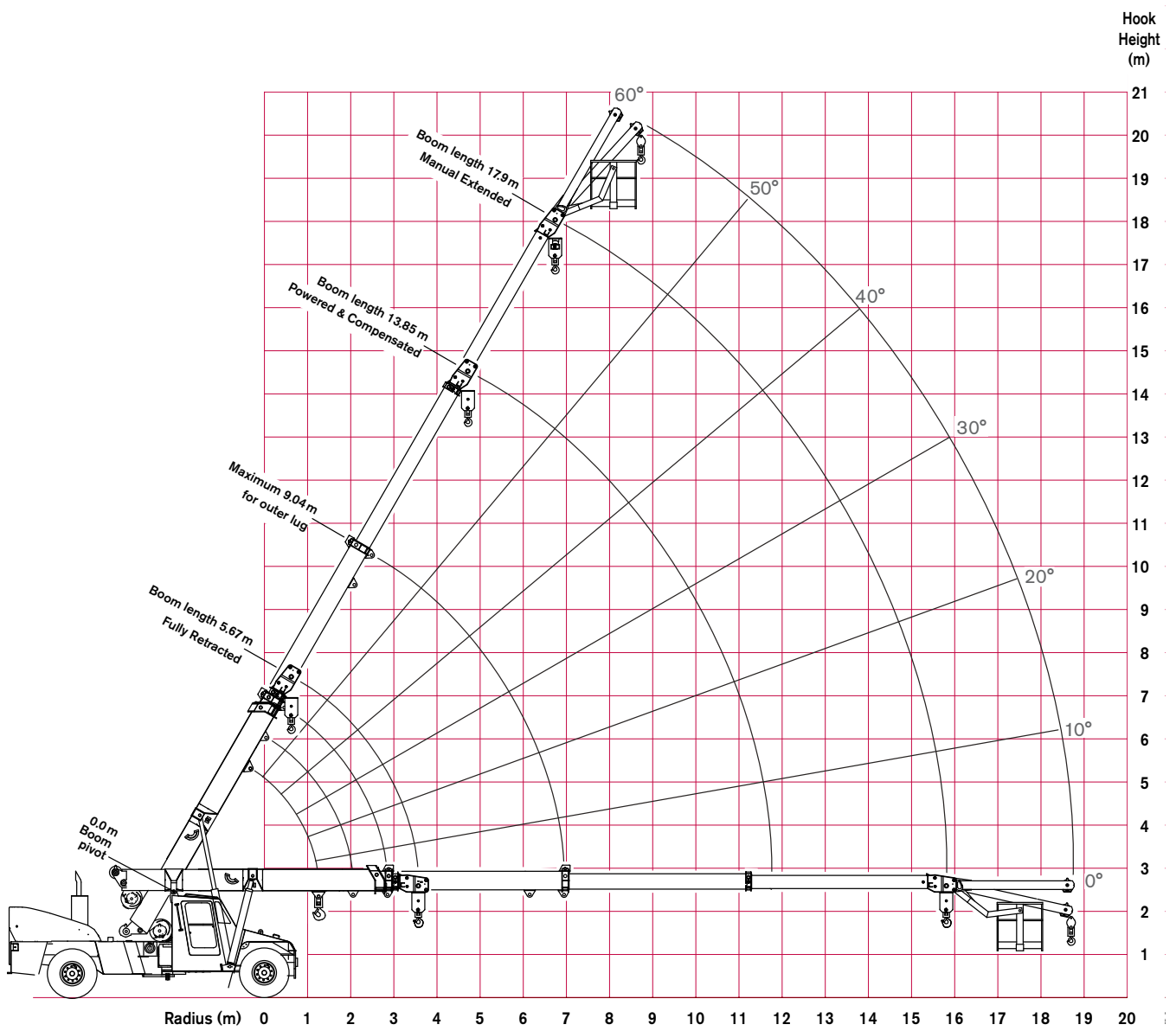

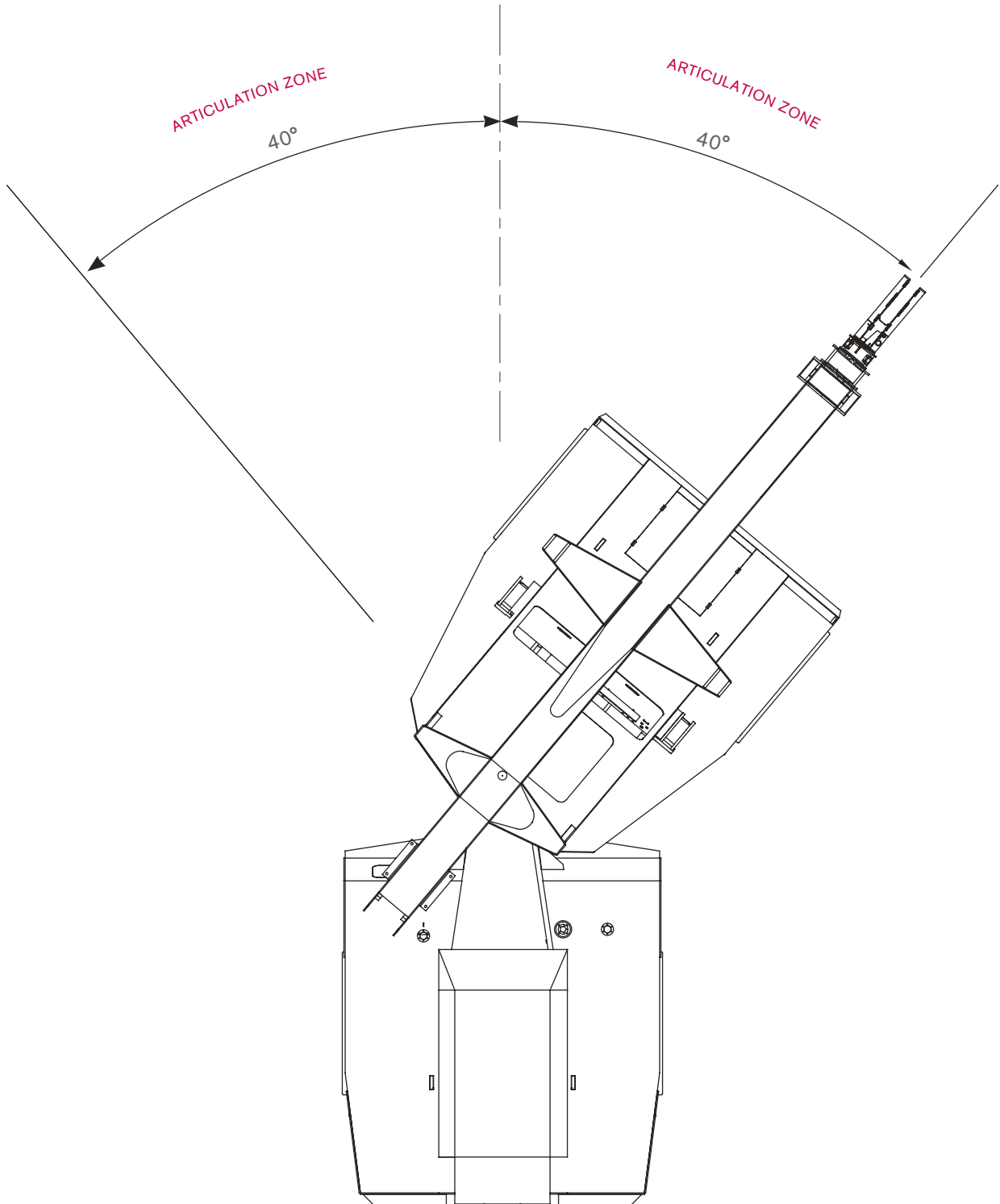

LOAD CHART

AT 22

Fallblock

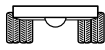

Pick & Carry 0.4 m/s (1.44 km/h); On rubber 66.6%



5.67–13.85 m

AS 1418.5

m	Boom Length (m)																		m
	5.67	6.00	6.50	7.00	7.50	8.00	8.50	9.00	9.50	10.00	10.50	11.00	11.50	12.00	12.50	13.00	13.50	13.85	
1.6	16800	16150	15350	14800															
	16800	16150	15350	14800															
2.0	16800	16800	16400	15600	15000	14600													
	16350	16350	16300	15600	15000	14600													
2.5	14600	14550	14550	14550	14500	14250	13700	13200											
	12900	12900	12900	12850	12850	12850	12850	12800											
3.0	12000	12000	12000	12000	11950	11950	11950	11950	11900	11150									
	10600	10600	10600	10600	10600	10550	10550	10550	10550	10550									
3.5	10150	10150	10150	10150	10150	10150	10100	10100	10100	10100	9450	8150							
	8950	9000	8950	8950	8950	8950	8950	8950	8900	8900	8900	8150							
4.0	9950	9000	8800	8750	8750	8750	8750	8750	8750	8700	8700	7600	7050	6800					
	8750	7950	7750	7750	7700	7700	7700	7700	7700	7700	7700	7600	7050	6800					
4.5			7900	7700	7700	7700	7700	7650	7650	7650	7650	7100	6600	6350	6100	5900			
			6950	6750	6750	6750	6750	6750	6750	6750	6750	6750	6600	6350	6100	5900			
5.0				7000	6850	6850	6850	6800	6800	6800	6800	6650	6200	5950	5700	5500	5350	5200	
				6150	6000	6000	6000	6000	6000	6000	6000	5950	5950	5950	5700	5500	5350	5200	
6.0					6250	5650	5550	5550	5550	5550	5550	5500	5500	5300	5050	4900	4700	4600	
					5500	4950	4850	4850	4850	4850	4850	4850	4800	4800	4800	4800	4700	4600	
7.0								5150	4700	4600	4600	4600	4600	4600	4550	4400	4250	4000	
								4500	4100	4000	4000	4000	4000	4000	4000	4000	4000	4000	
8.0										4300	4000	3900	3900	3900	3900	3900	3850	3700	3600
										3750	3450	3400	3400	3400	3400	3400	3400	3400	
9.0												3700	3400	3400	3400	3400	3400	3400	3300
												3200	2950	2900	2900	2900	2900	2900	
10.0														3200	3000	2950	2950	2950	2950
														2750	2500	2500	2500	2500	
11.0																2800	2600	2600	2600
																2300	2150	2100	2100
11.75																		2450	2350
																		1950	1850

- RC (kg) at 0° articulation
- RC (kg) at 40° articulation
- Boom angle
- Radius at 0° boom angle
- Loads above red line are structural

Notes to lifting capacity

Lifting capacities do not exceed 66.6% of tipping load. Weight of hook blocks and slings is part of the load, and is to be deducted from the capacity ratings. Consult Rated Capacity Manual for further details.

Note: Data published herein is intended as a guide only and shall not be construed to warrant applicability for lifting purposes. Crane operation is subject to the computer charts and Rated Capacity Manual both supplied with the crane.

LOAD CHART

AT 22

Fallblock, Manual

 Pick & Carry 0.4 m/s (1.44 km/h); On rubber 66.6%

 9.72–17.90 m

AS 1418.5

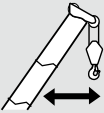
Maximum Radius 	Rated Capacity Maximum Extension Maximum Length 17.90 m
	m / kg
6.74	2900
	2900
	60°
9.31	2500
	2500
	50°
11.53	2250
	2150
	40°
13.34	2050
	1700
	30°
14.67	1850
	1400
	20°
15.51	1750
	1300
	10°
15.80	1700
	1250
	0°

Notes to lifting capacity

Read and understand warning notes before operating crane.

Weight of slings & hook block to be added to load.

Maximum extension length is 17.90 m.

17.9 m boom length includes manual 3rd extension.

Ratings for manual extension are structural and based on boom angle, not radius.





The ratings do not change if the power sections are retracted with the manual section extended.

Lifting capacities do not exceed 66.6% of tipping load.





Weight of hook blocks and slings is part of the load, and is to be deducted from the capacity ratings.

Consult Rated Capacity Manual for further details.





Data published herein is intended as a guide only and shall not be construed to warrant applicability for lifting purposes. Crane operation is subject to the computer charts and Rated Capacity Manual both supplied with the crane.

-  RC (kg) at 0° articulation
-  RC (kg) at 40° articulation
-  Boom angle
-  Loads above red line are structural



Boom and Jib

	Four section boom: Main boom, two powered sections, and one manual section (3rd section)	
	Maximum hook height	17 m
	Boom elevation angle range (min. / max.)	-6° / 60°
	Maximum hook height with jib	20 m
	40° articulation each side of centre providing a total 80° slewing arc	80°
	Machinery hook	10 tonne

Winch

	Winch: Fully compensated hook height when telescoping boom 1 and 2	
	Maximum line pull	4.2 tonne
	Two speed winch	41 m/min / 82 m/min
	Hook block, four part, maximum rated capacity	16.8 tonne



Engine and Transmission

	Mercedes OM 906 EUROMOT 3a turbo charged and intercooled diesel engine with hinged engine cover and mid cover for easy serviceability	205 kW
	Engine torque	1110 Nm
	Fuel capacity	440 l
	Fuel type	diesel
	Allison 3000	6-speed automatic
	Transfer Case: Styer VG 750 2:1 ratio High/low range via airshirt 2WD/4WD via airshift, disconnect to rear axle	

Hydraulic System

	Hydraulic Pump:	
	Load sensing axial piston	
	Maximum pump flow rate	130 litre/min
	Maximum working pressure	250 bar
Hydraulic tank with top mounted return and in tank suction filters		200 l

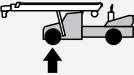
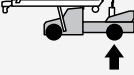
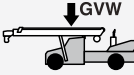
Chassis

	Front Axle: Kessler D71 PL478 heavy duty high speed planetary axle with driver selectable diff lock	8,000 kg
	Rear Axle: Kessler D71 PL478 heavy duty high speed planetary axle	12,000 kg
	Total:	20,000 kg
	Full power Orbitrol with twin hydraulic double acting rams with end stop cushioning Priority flow from main pump supply plus electro hydraulic emergency supply Turning Circle: Outside wheels radius	7.4 m
	Brakes: Air operated high capacity Large wedge style twin circuit service and spring applied park brakes on both front and rear axles Crane operation hold brake on right side front wheel Driver selectable engine exhaust brake is available in all gears - automatically selects converter lockup	
	Suspension: Two semi elliptic springs on front and rear axle plus torsion bar on front axle for stability	



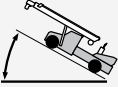

Tyres

	12.00 x 20 bias ply duals 20 in x 8.5 in heavy duty ISO 10 stud 335 PCD spigot mount rims
---	--

Vehicle performance

	Maximum rated travel speed	85 kph
	Gradeability	50%

Cab, Controls, and Operator aids

	Two person, insulated lock up cabin: <ul style="list-style-type: none">ISRI suspension driver's and passenger seats, including retracting seat beltsColour LCD displayClarion MP3 player with integrated GPS with Bluetooth handsfreeReversing cameraCentralised greasingCruise controlEngine monitoringService diagnostics
	Robway rated capacity indicator - dynamically calculates rated capacity on slopes. Provides audio/visual overload pre-warning and motion cut-outs.
	3 axis joystick control for crane functions
	Air conditioned and heated

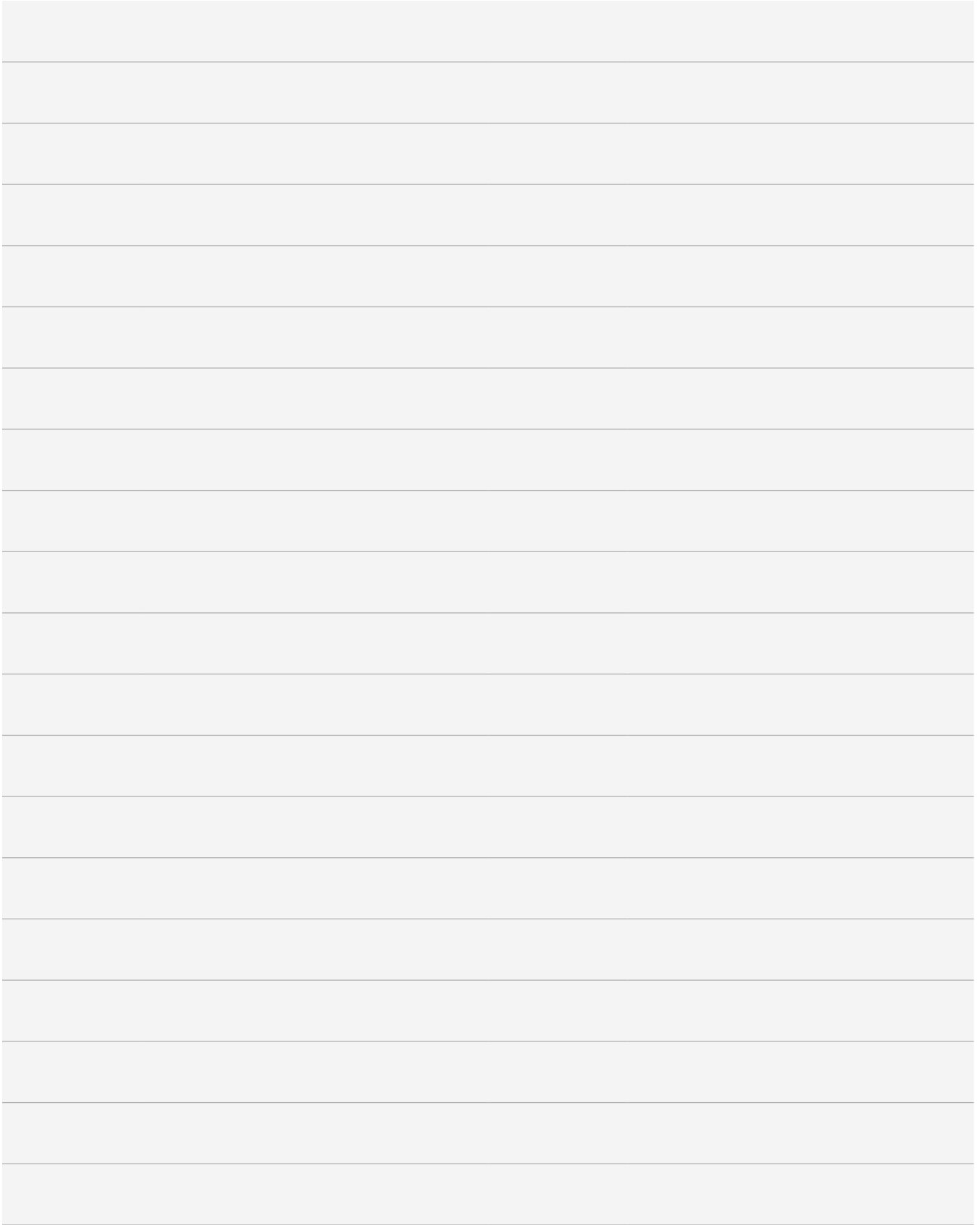

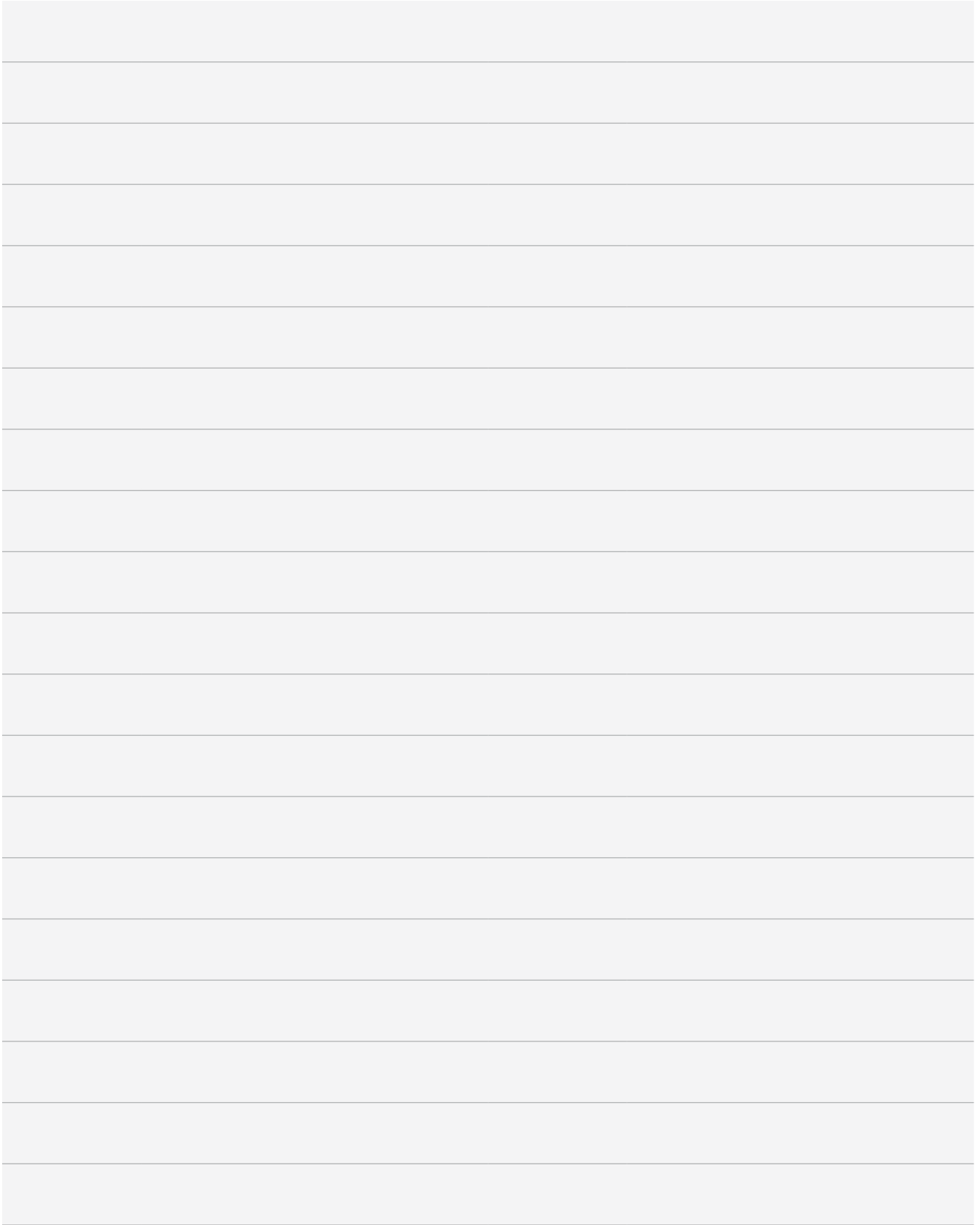

BRISBANE

585 Curtin Avenue East
Eagle Farm QLD 4009
AUSTRALIA

Ph: +61 7 3868 9600
Fax: +61 7 3268 2489

MELBOURNE

187 Osborne Avenue
Clayton South VIC 3169
AUSTRALIA

Ph: +61 3 9551 8644
Fax: +61 3 9551 8143

SYDNEY

114 Hassall Street
Wetherill Park NSW 2164
AUSTRALIA

Ph: +61 2 8786 4444
Fax: +61 2 8786 4455

PERTH

39 Catalano Road
Canning Vale WA 6155
AUSTRALIA

Ph: +61 8 9232 0000
Fax: +61 8 9232 0051

Effective Date: February 2014. Product specifications and prices are subject to change without notice or obligation. The photographs and/or drawings in this document are for illustrative purposes only. Refer to the appropriate Operator's Manual for instructions on the proper use of this equipment. Failure to follow the appropriate Operator's Manual when using our equipment or to otherwise act irresponsibly may result in serious injury or death. The only warranty applicable to our equipment is the standard written warranty applicable to the particular product and sale and Terex makes no other warranty, express or implied. Products and services listed may be trademarks, service marks or trade-names of Terex Corporation and/or its subsidiaries in the USA and other countries. All rights are reserved. Terex® is a registered trademark of Terex Corporation in the USA and many other countries. Copyright 2014 Terex Corporation.

Terex Cranes, Global Marketing, Dinglerstraße 24, 66482 Zweibrücken, Germany
Tel. +49 (0) 6332 830, Email: info.cranes@terex.com, www.terexcranes.com



www.terexcranes.com

Brochure Reference: TC-DS-M-E-AT22-02/14



WORKS FOR YOU.™